

Insulated Gate Bipolar Transistor (Trench IGBT), 100 A

SOT-227

PRODUCT SUMMARY	
V_{CES}	600 V
I_C DC	100 A at 117 °C
$V_{CE(on)}$ typical at 100 A, 25 °C	1.72 V
I_F DC	100 A at 25 °C

FEATURES

- Trench IGBT technology with positive temperature coefficient
- Square RBSOA
- 3 μ s short circuit capability
- FRED Pt® antiparallel diodes with ultrasoft reverse recovery
- T_J maximum = 175 °C
- Fully isolated package
- Very low internal inductance (≤ 5 nH typical)
- Industry standard outline
- UL approved file E78996
- Compliant to RoHS directive 2002/95/EC

**RoHS
COMPLIANT**
BENEFITS

- Designed for increased operating efficiency in power conversion: UPS, SMPS, welding, induction heating
- Easy to assemble and parallel
- Direct mounting to heatsink
- Plug-in compatible with other SOT-227 packages
- Speed 4 kHz to 30 kHz
- Lower conduction losses and switching losses
- Low EMI, requires less snubbing

ABSOLUTE MAXIMUM RATINGS				
PARAMETER	SYMBOL	TEST CONDITIONS	MAX.	UNITS
Collector to emitter voltage	V_{CES}		600	V
Continuous collector current	I_C ⁽¹⁾	$T_C = 25$ °C	184	A
		$T_C = 80$ °C	137	
Pulsed collector current	I_{CM}		350	
Clamped inductive load current	I_{LM}		350	
Diode continuous forward current	I_F	$T_C = 25$ °C	100	
		$T_C = 80$ °C	71	
Peak diode forward current	I_{FSM}		200	
Gate to emitter voltage	V_{GE}		± 20	V
Power dissipation, IGBT	P_D	$T_C = 25$ °C	577	W
		$T_C = 117$ °C	223	
Power dissipation, diode	P_D	$T_C = 25$ °C	205	
		$T_C = 117$ °C	79	
Isolation voltage	V_{ISOL}	Any terminal to case, $t = 1$ min	2500	V

Note

⁽¹⁾ Maximum continuous collector current must be limited to 100 A to do not exceed the maximum temperature of terminals

ELECTRICAL SPECIFICATIONS ($T_J = 25\text{ }^\circ\text{C}$ unless otherwise specified)						
PARAMETER	SYMBOL	TEST CONDITIONS	MIN.	TYP.	MAX.	UNITS
Collector to emitter breakdown voltage	$V_{BR(CES)}$	$V_{GE} = 0\text{ V}, I_C = 250\text{ }\mu\text{A}$	600	-	-	V
Collector to emitter voltage	$V_{CE(on)}$	$V_{GE} = 15\text{ V}, I_C = 100\text{ A}$	-	1.72	2.0	
		$V_{GE} = 15\text{ V}, I_C = 100\text{ A}, T_J = 125\text{ }^\circ\text{C}$	-	2.0	2.2	
Gate threshold voltage	$V_{GE(th)}$	$V_{CE} = V_{GE}, I_C = 250\text{ }\mu\text{A}$	3.5	4.6	6.5	
Temperature coefficient of threshold voltage	$\Delta V_{GE(th)}/\Delta T_J$	$V_{CE} = V_{GE}, I_C = 1\text{ mA}$ (25 °C to 125 °C)	-	- 16.8	-	mV/°C
Collector to emitter leakage current	I_{CES}	$V_{GE} = 0\text{ V}, V_{CE} = 600\text{ V}$	-	0.6	100	μA
		$V_{GE} = 0\text{ V}, V_{CE} = 600\text{ V}, T_J = 125\text{ }^\circ\text{C}$	-	0.15	3	mA
Forward voltage drop	V_{FM}	$I_F = 40\text{ A}, V_{GE} = 0\text{ V}$	-	1.78	2.21	V
		$I_F = 40\text{ A}, V_{GE} = 0\text{ V}, T_J = 125\text{ }^\circ\text{C}$	-	1.39	1.74	
Gate to emitter leakage current	I_{GES}	$V_{GE} = \pm 20\text{ V}$	-	-	± 200	nA

SWITCHING CHARACTERISTICS ($T_J = 25\text{ }^\circ\text{C}$ unless otherwise specified)						
PARAMETER	SYMBOL	TEST CONDITIONS	MIN.	TYP.	MAX.	UNITS
Turn-on switching loss	E_{on}	$I_C = 100\text{ A}, V_{CC} = 360\text{ V},$ $V_{GE} = 15\text{ V}, R_g = 5\text{ }\Omega,$ $L = 500\text{ }\mu\text{H}, T_J = 25\text{ }^\circ\text{C}$	-	0.35	-	mJ
Turn-off switching loss	E_{off}		-	2.08	-	
Total switching loss	E_{tot}		-	2.43	-	
Turn-on switching loss	E_{on}		-	0.41	-	
Turn-off switching loss	E_{off}		-	2.83	-	
Total switching loss	E_{tot}		-	3.24	-	
Turn-on delay time	$t_{d(on)}$	$I_C = 100\text{ A}, V_{CC} = 360\text{ V},$ $V_{GE} = 15\text{ V}, R_g = 5\text{ }\Omega,$ $L = 500\text{ }\mu\text{H}, T_J = 125\text{ }^\circ\text{C}$	-	162	-	ns
Rise time	t_r		-	55	-	
Turn-off delay time	$t_{d(off)}$		-	150	-	
Fall time	t_f		-	129	-	
Reverse bias safe operating area	RBSOA	$T_J = 175\text{ }^\circ\text{C}, I_C = 350\text{ A}, R_g = 22\text{ }\Omega,$ $V_{GE} = 15\text{ V to } 0\text{ V}, V_{CC} = 400\text{ V},$ $V_P = 600\text{ V}, L = 500\text{ }\mu\text{H}$	Fullsquare			
Diode reverse recovery time	t_{rr}	$I_F = 50\text{ A}, di_F/dt = 200\text{ A}/\mu\text{s}, V_R = 200\text{ V}$	-	61	85	ns
Diode peak reverse current	I_{rr}		-	4	7	A
Diode recovery charge	Q_{rr}		-	120	297	nC
Diode reverse recovery time	t_{rr}	$I_F = 50\text{ A}, di_F/dt = 200\text{ A}/\mu\text{s},$ $V_R = 200\text{ V}, T_J = 125\text{ }^\circ\text{C}$	-	133	154	ns
Diode peak reverse current	I_{rr}		-	12	15	A
Diode recovery charge	Q_{rr}		-	750	1150	nC
Short circuit safe operating area	SCSOA	$T_J = 175\text{ }^\circ\text{C}, R_g = 22\text{ }\Omega,$ $V_{GE} = 15\text{ V to } 0\text{ V}, V_{CC} = 400\text{ V},$ $V_P = 600\text{ V}$	3			μs



THERMAL AND MECHANICAL SPECIFICATIONS					
PARAMETER	SYMBOL	MIN.	TYP.	MAX.	UNITS
Maximum junction and storage temperature range	T_J, T_{Stg}	- 40	-	175	°C
Junction to case	IGBT	-	-	0.26	°C/W
	Diode	-	-	0.73	
Case to sink per module	R_{thCS}	-	0.05	-	
Mounting torque, 6-32 or M3 screw		-	-	1.3	Nm
Weight		-	30	-	g

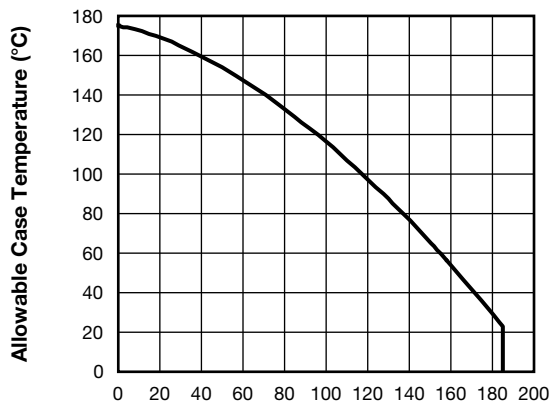

93185_01 **I_C - Continuous Collector Current (A)**

Fig. 1 - Maximum DC IGBT Collector Current vs. Case Temperature

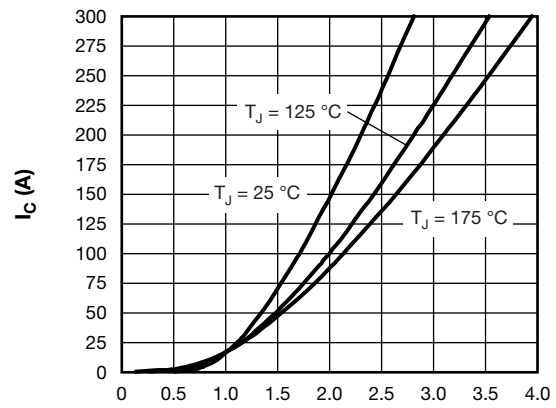

93185_02 **V_{CE} (V)**

Fig. 3 - Typical IGBT Collector Current Characteristics $V_{GE} = 15$ V

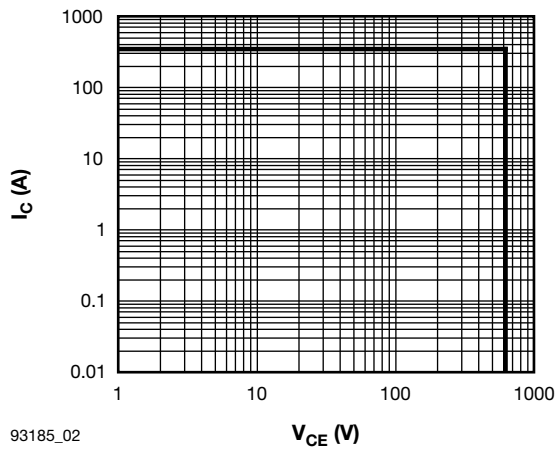

93185_02

Fig. 2 - IGBT Reverse Bias SOA $T_J = 175$ °C, $V_{GE} = 15$ V

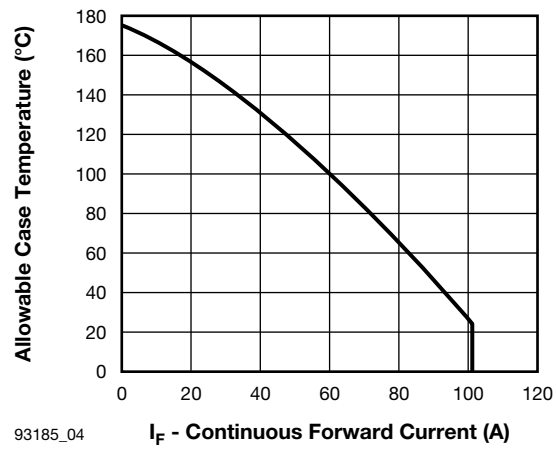

93185_04 **I_F - Continuous Forward Current (A)**

Fig. 4 - Maximum DC Forward Current vs. Case Temperature

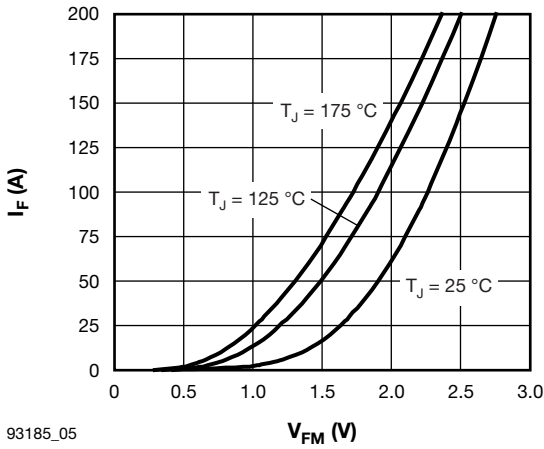

Fig. 5 - Typical Diode Forward Characteristics

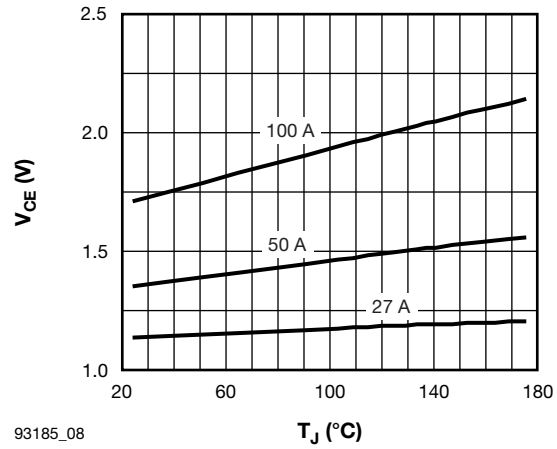

Fig. 8 - Typical IGBT Collector to Emitter Voltage vs. Junction Temperature, $V_{GE} = 15\text{ V}$

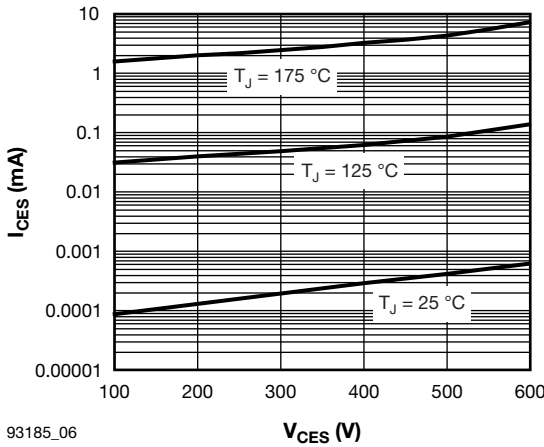

Fig. 6 - Typical IGBT Zero Gate Voltage Collector Current

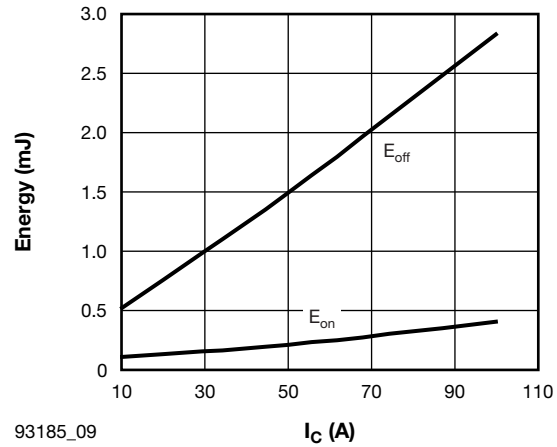

Fig. 9 - Typical IGBT Energy Loss vs. I_C
 $T_J = 125\text{ °C}$, $L = 500\text{ }\mu\text{H}$, $V_{CC} = 360\text{ V}$,
 $R_g = 5\text{ }\Omega$, $V_{GE} = 15\text{ V}$

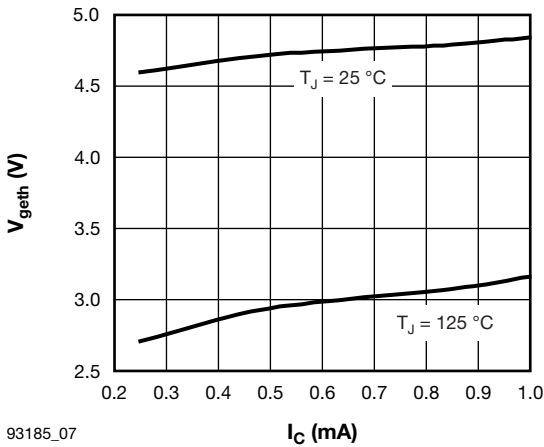

Fig. 7 - Typical IGBT Threshold Voltage

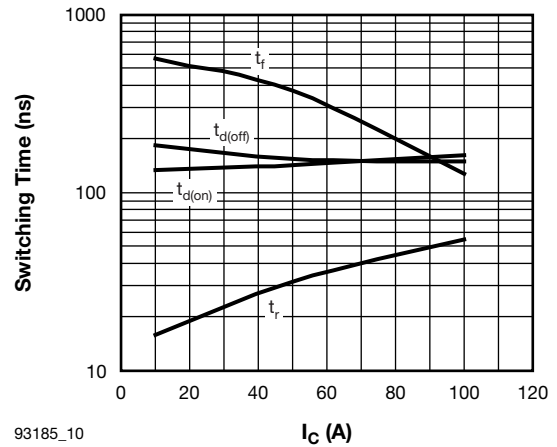
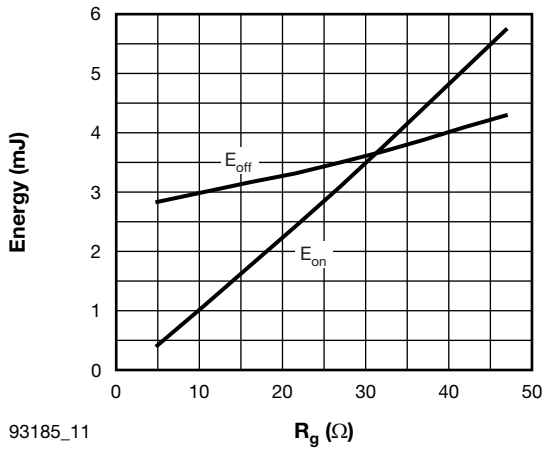
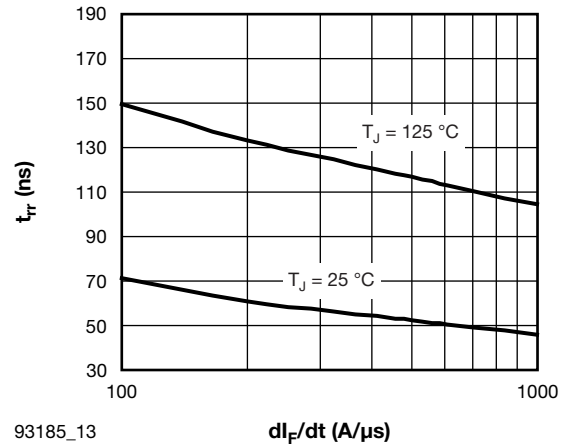

Fig. 10 - Typical IGBT Switching Time vs. I_C
 $T_J = 125\text{ °C}$, $L = 500\text{ }\mu\text{H}$, $V_{CC} = 360\text{ V}$,
 $R_g = 5\text{ }\Omega$, $V_{GE} = 15\text{ V}$



93185_11

Fig. 11 - Typical IGBT Energy Loss vs. R_g
 $T_J = 125^\circ\text{C}$, $I_C = 100\text{ A}$, $L = 500\ \mu\text{H}$,
 $V_{CC} = 360\text{ V}$, $V_{GE} = 15\text{ V}$



93185_13

Fig. 13 - Typical t_{rr} Diode vs. dI_F/dt
 $V_{rr} = 200\text{ V}$, $I_F = 50\text{ A}$

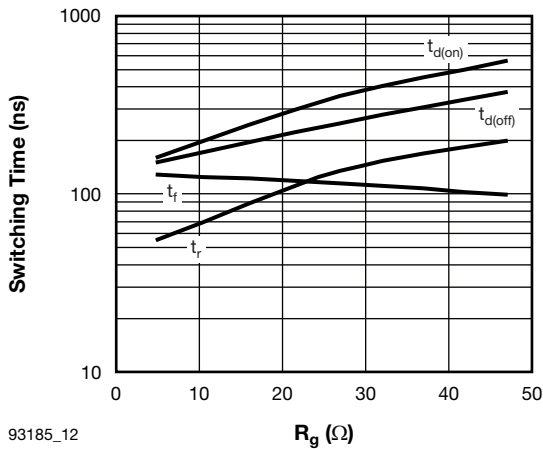

93185_12

Fig. 12 - Typical IGBT Switching Time vs. R_g
 $T_J = 125^\circ\text{C}$, $L = 500\ \mu\text{H}$, $V_{CC} = 360\text{ V}$,
 $I_C = 100\text{ A}$, $V_{GE} = 15\text{ V}$

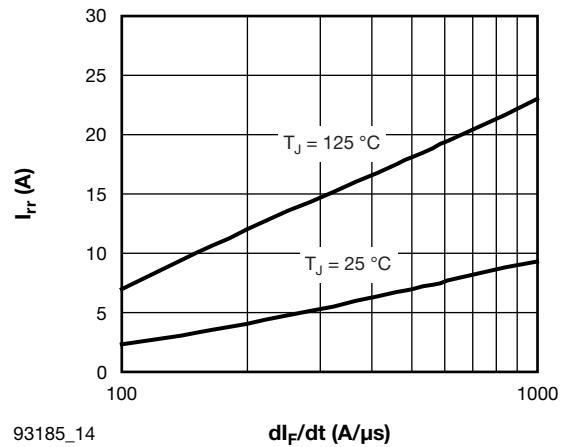

93185_14

Fig. 14 - Typical I_{rr} Diode vs. dI_F/dt
 $V_{rr} = 200\text{ V}$, $I_F = 50\text{ A}$

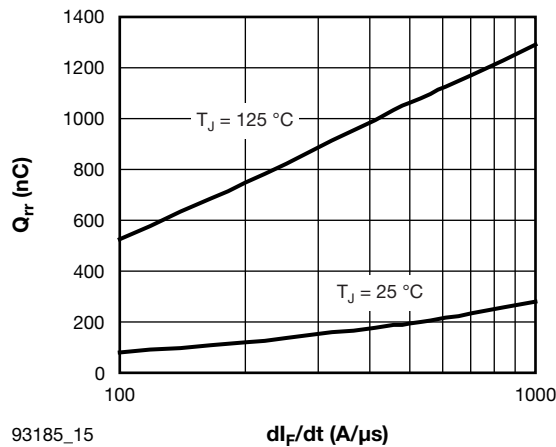

93185_15

Fig. 15 - Typical Q_{rr} Diode vs. dI_F/dt
 $V_{rr} = 200\text{ V}$, $I_F = 50\text{ A}$

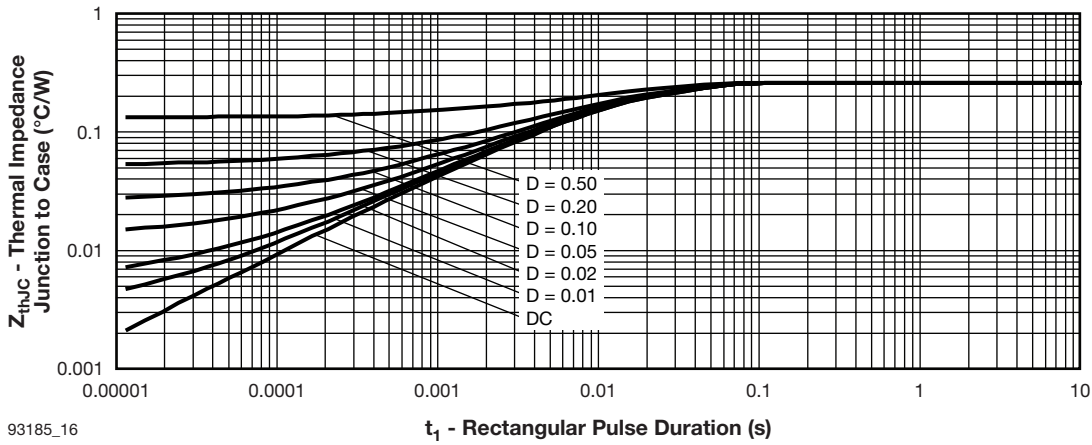

Fig. 16 - Maximum Thermal Impedance Z_{thJC} Characteristics (IGBT)

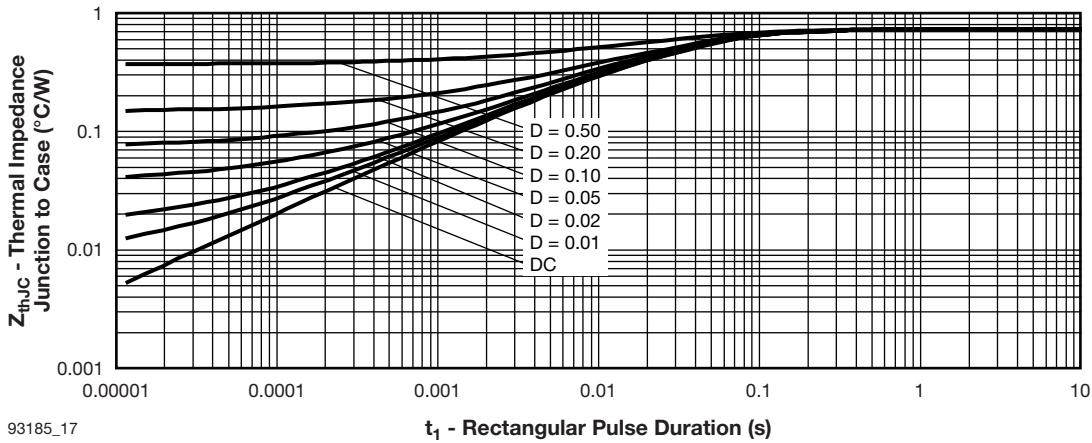
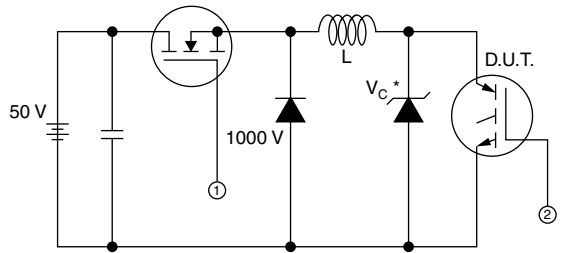

Fig. 17 - Maximum Thermal Impedance Z_{thJC} Characteristics (Diode)



* Driver same type as D.U.T.; $V_C = 80\%$ of $V_{ce(max)}$
 * Note: Due to the 50 V power supply, pulse width and inductor will increase to obtain I_d

Fig. 18a - Clamped Inductive Load Test Circuit

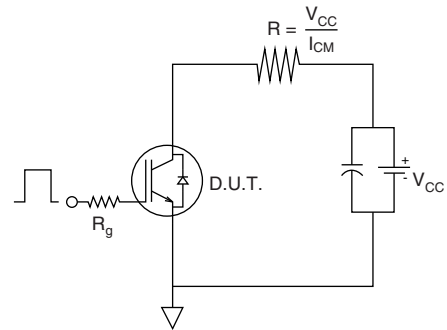

Fig. 18b - Pulsed Collector Current Test Circuit

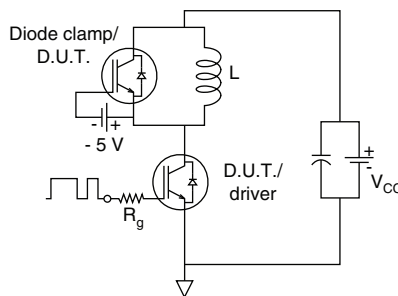

Fig. 19a - Switching Loss Test Circuit

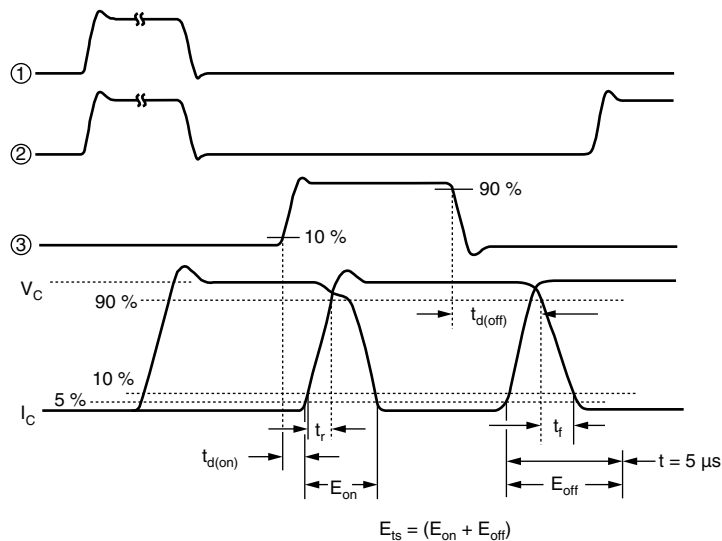

Fig. 19b - Switching Loss Waveforms Test Circuit

GT100DA60U

Vishay Semiconductors

Insulated Gate Bipolar Transistor
(Trench IGBT), 100 A



ORDERING INFORMATION TABLE

Device code	G	T	100	D	A	60	U
	①	②	③	④	⑤	⑥	⑦

- 1** - Insulated Gate Bipolar Transistor (IGBT)
- 2** - T = Trench IGBT technology
- 3** - Current rating (100 = 100 A)
- 4** - Circuit configuration (D = Single switch with antiparallel diode)
- 5** - Package indicator (A = SOT-227)
- 6** - Voltage rating (60 = 600 V)
- 7** - Speed/type (U = Ultrafast)

CIRCUIT CONFIGURATION

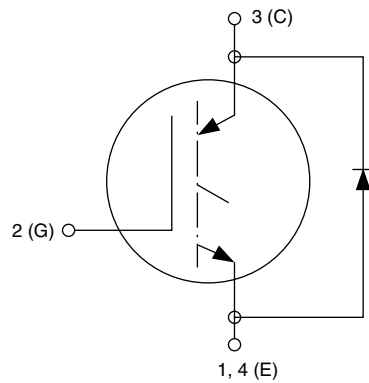

LINKS TO RELATED DOCUMENTS	
Dimensions	www.vishay.com/doc?95036
Packaging information	www.vishay.com/doc?95037

SOT-227

DIMENSIONS in millimeters (inches)

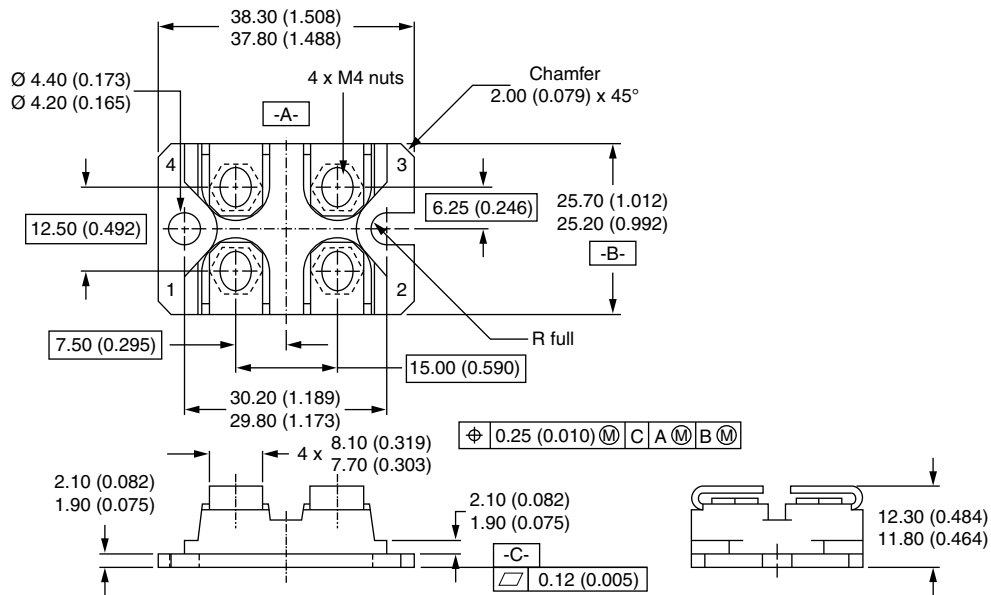

Notes

- Dimensioning and tolerancing per ANSI Y14.5M-1982
- Controlling dimension: millimeter



Disclaimer

ALL PRODUCT, PRODUCT SPECIFICATIONS AND DATA ARE SUBJECT TO CHANGE WITHOUT NOTICE TO IMPROVE RELIABILITY, FUNCTION OR DESIGN OR OTHERWISE.

Vishay Intertechnology, Inc., its affiliates, agents, and employees, and all persons acting on its or their behalf (collectively, "Vishay"), disclaim any and all liability for any errors, inaccuracies or incompleteness contained in any datasheet or in any other disclosure relating to any product.

Vishay makes no warranty, representation or guarantee regarding the suitability of the products for any particular purpose or the continuing production of any product. To the maximum extent permitted by applicable law, Vishay disclaims (i) any and all liability arising out of the application or use of any product, (ii) any and all liability, including without limitation special, consequential or incidental damages, and (iii) any and all implied warranties, including warranties of fitness for particular purpose, non-infringement and merchantability.

Statements regarding the suitability of products for certain types of applications are based on Vishay's knowledge of typical requirements that are often placed on Vishay products in generic applications. Such statements are not binding statements about the suitability of products for a particular application. It is the customer's responsibility to validate that a particular product with the properties described in the product specification is suitable for use in a particular application. Parameters provided in datasheets and/or specifications may vary in different applications and performance may vary over time. All operating parameters, including typical parameters, must be validated for each customer application by the customer's technical experts. Product specifications do not expand or otherwise modify Vishay's terms and conditions of purchase, including but not limited to the warranty expressed therein.

Except as expressly indicated in writing, Vishay products are not designed for use in medical, life-saving, or life-sustaining applications or for any other application in which the failure of the Vishay product could result in personal injury or death. Customers using or selling Vishay products not expressly indicated for use in such applications do so at their own risk and agree to fully indemnify and hold Vishay and its distributors harmless from and against any and all claims, liabilities, expenses and damages arising or resulting in connection with such use or sale, including attorneys fees, even if such claim alleges that Vishay or its distributor was negligent regarding the design or manufacture of the part. Please contact authorized Vishay personnel to obtain written terms and conditions regarding products designed for such applications.

No license, express or implied, by estoppel or otherwise, to any intellectual property rights is granted by this document or by any conduct of Vishay. Product names and markings noted herein may be trademarks of their respective owners.